

# LVS344PM



<b>Product Family</b>	Dishwashers
<b>Colour</b>	Stainless steel
<b>Finishing</b>	Fingerproof
<b>Width</b>	60 cm
<b>Commercial height</b>	85 cm
<b>Installation</b>	Free-standing
<b>N° baskets</b>	3, FlexiDuo
<b>Motor</b>	Inverter 2.0
<b>Type</b>	Semi professional
<b>EAN code</b>	8017709307356



## Programs / Functions



<b>No. of programmes</b>	10+1	<b>Auto sensor 45-65</b>	Yes
<b>Washing temperatures</b>	45, 50, 65, 70, 75 °C	<b>Mix</b>	Yes
<b>Soak</b>	Yes	<b>Intense</b>	Yes
<b>Crystal</b>	Yes	<b>Self clean</b>	Yes
<b>Crystal Pro</b>	Yes	<b>Hygiene 99,9%</b>	Yes
<b>Full express - 60 minutes</b>	Yes	<b>Ultra Express</b>	Yes
<b>ECO</b>	Yes		

## Options



<b>Dry Assist+ option</b>	Yes	<b>1/2 load FlexiZone option (varied distribution)</b>	Yes
<b>Delay timer option</b>	Up to 24 hours, with automatic soak	<b>Professional option</b>	Yes

## Baskets



<b>Basket colour</b>	Grey	<b>Sliding Guides Extra Glide</b>	Yes
<b>Basket components colour</b>	Grey	<b>Largest loadable dish in upper basket</b>	19,0 cm
		<b>Lower Basket</b>	With 4 foldable racks

<b>Handle</b>	In plastic with stainless steel insert on upper and lower basket	<b>Lower basket with anti-drip inserts</b>	Yes
<b>Upper Basket</b>	With 3 foldable racks	<b>Largest loadable dish in lower basket</b>	30,0 cm
<b>Glass holder</b>	Yes	<b>Colour Inner Components</b>	Blue
<b>Height adjustment of the upper basket</b>	On three levels		

## Technical Features



<b>Width (mm)</b>	598 mm	<b>Turbidity sensor Aquatest</b>	Yes
<b>Depth (mm)</b>	600 mm	<b>Flood protection system</b>	Total Acquastop
<b>Display type</b>	LED display	<b>Water supply</b>	Single; cold/hot water max. 60°C - energysave with hot water up to 35%
<b>Product Height (mm)</b>	850 mm	<b>Max water hardness</b>	100°FH;58°dH
<b>Controls</b>	Electronic	<b>Drying system</b>	Natural condenser drying, with Dry Assist + automatic door opening system at the end of the cycle
<b>Display</b>	Delayed start, Programme time indicator, Time to end indication	<b>Tank material</b>	Stainless steel
<b>Programme graphics</b>	Symbols	<b>Filter</b>	Stainless steel
<b>Salt light indicator</b>	Light	<b>Concealed heating element</b>	Yes
<b>Rinse aid indicator</b>	Light	<b>Hinges</b>	Self balancing with fixed hinges
<b>Progress indicator</b>	Yes	<b>Adjustable feet</b>	Just for levelling
<b>End of cycle indicator</b>	On display, with acoustic signal	<b>Back cover</b>	Yes
<b>Washing system</b>	Planetarium	<b>Depth of dishwasher with open door (mm)</b>	1168
<b>Third spray arm</b>	Single	<b>Removable top</b>	Yes, with optional KIT
<b>Water softener</b>	With electronic setting	<b>Top cover</b>	In plastic

## Performance / Energy Label NEW

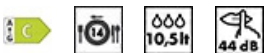

<b>Energy Efficiency Class (Washing cycle)</b>	C	<b>Programme duration</b>	4:25 h:min
<b>Energy consumption [per 100 cycles, based on the eco programme]</b>	75 KWh	<b>Airborne acoustical noise emissions (spinning phase)</b>	44 dB(A) re 1 pW
<b>Rated capacity (ps)</b>	14	<b>Airborne acoustical noise emission class</b>	B
<b>Water consumption [per cycle]</b>	10.5 litres	<b>Energy efficiency Index (EEI) (Washing cycle)</b>	43.8

## Electrical Connection

---

<b>Connected power</b>	5450 W	<b>Frequency (Hz)</b>	50 Hz
<b>Current</b>	32 A	<b>Type of connection</b>	Single-phase
<b>Voltage</b>	220-240 V	<b>Power supply cable length</b>	200 cm

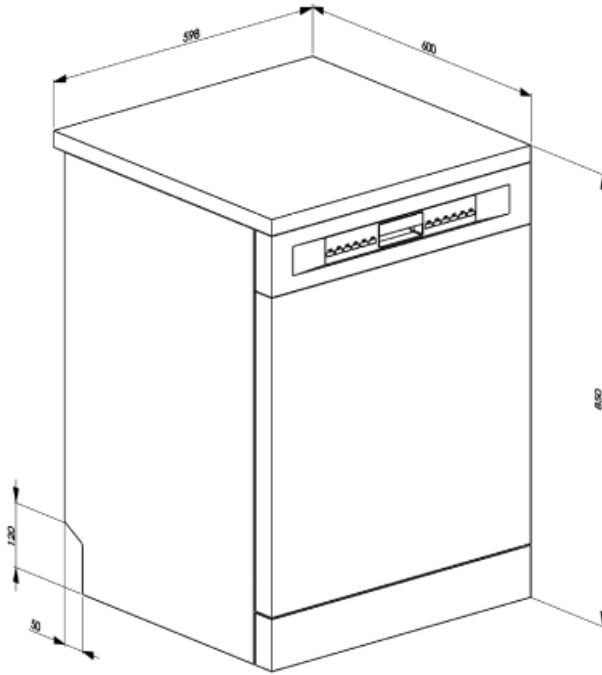

---

## Not included accessories

---

### KITINC

a steel bar fitted on the top will block the dishwasher at the top.

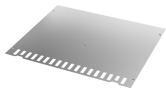

### KITGH

Kit glass holder. It has to be fitted on the first basket but only if there are foldable racks

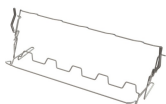























### KITPLV2

Kit extension for dishwasher and washing machine: length mt. 2



## Symbols glossary

	Aquatest measures the clarity of the water during an auto program, and automatically ensures the minimum consumption of water and energy.		Anti-drip: Some models of dishwashers are equipped with special polymer nozzles anti-drip, that improve the process of drying.
	Delay Timer: The delay timer can postpone the start of the program by up to 24 hours.		Energy efficiency class C
	The Dry Assist + option, in addition to saving energy, ensures perfect drying of the dishes by opening the door automatically at the end of the wash c		Fingerprint proof stainless steel: Fingerprint proof stainless steel keeps stainless steel looking as good as new.
	FlexiDuo: The FlexiDuo 3rd cutlery basket allows you to arrange cutlery or small cups, ladles, or bulky utensils however you like: it consists of two separate and moveable modules.		FlexiZone: The ½ load flexizone allows you to wash a reduced load saving energy, water and time and there are no restrictions on where the items are placed.
	The new ExtraGlide guide system, available on top of the range models, makes the second basket even smoother and softer. In fact, it facilitates the extraction of the introduction, even at full load and, for the greater excursion, the insertion of crockery is also facilitated in the rear part.		Noise Level: Excellent insulation and special devices keep noise to a minimum.
	PLANETARIUM_WASHING_SYSTEM_72dpi		Auto 45°- 65°: The auto programme regulates the length of a cycle depending on the need for a pre-wash and the number of rinses required.
	Crystals: The Crystals programme is dedicated to delicate dishes such as glasses and china.		Eco: Eco, this economic wash programme uses a low amount of water and energy in order to provide the most environmentally friendly cleaning option.
	Normal programme: The normal programme is suitable for normal degrees of dirt for everyday use.		Soak programme: The soak programme provides a rinse to prevent dirt from drying.
	Ultraclean: The Ultraclean option performs a final rinse at a high temperature of 70°C eliminating virtually all bacteria.		Professional: Option Professional enables to convert household appliances into semiprofessional ones due to the programs which significantly reduce washing time to obtain an astonishing 16 minutes cycle.
	Quick Time: The Quick Time option can reduce the length of the wash cycle up to 55%.		...
	...		Special quick program for washing glasses.



**HYGIENE 99.9%** High-temperature washing programme. The 75° rinse guarantees the removal of 99.9% of germs and bacteria, making it ideal for sanitising



The work aimed at continuous improvement has allowed the creation of the second generation of the Inverter motor 2.0, characterised by greater efficiency and durability over time, which allows very high performance and a lower energy consumption and noise level.



The symbols show the number of plate settings of the dishwasher.



**Total Acquastop:** In addition to the partial Acquastop protection present in all Smeg dishwashers, some models have an electronic device fitted to the water intake hose, which monitors water levels in the machine, detects leaks in the hose and switches off the water supply immediately when necessary.



**System WaterSave** ensures the best washing results with minimal water consumption depending on the model of dishwasher.